





USE AND CARE GUIDE

LOW VOLTAGE LANDSCAPE LIGHTING

 **WARNING:** This luminaire is intended for installation in accordance with local codes and the National Electric Code (NEC). Failure to adhere to these codes and instructions may result in serious injury, property damage and void the warranty. When using multiple fixtures, do not exceed the total wattage load as specified by the transformer rating. This product is designed for above ground installation only. Keep these installation instructions for future use.

 **CAUTION:** Make sure all connectors are tightly secured to prevent water entry.

 **CAUTION:** Only for use with low voltage landscape lighting power units with a maximum output rating of 12 volts, 25A per secondary. Use G5.3 Bi-Pin MR16 LED lamps (maximum 15 watts).

 **CAUTION:** Install the fixtures no less than ten feet (3.05m) from pools, spas, or fountains to minimize risk of electric shock. Always use UL listed wire and wire connectors for connections.

Account for small parts and discard packing material, as these may be hazardous to children.

TOOLS REQUIRED (not supplied)



HARDWARE CONTENTS Note: Hardware not shown actual size.

FIXTURE PARTS

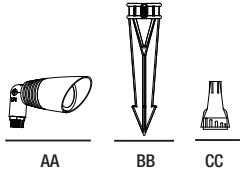

Part	Description	Quantity
AA	Fixture Body	1
BB	8" Ground Stake	1
CC	Waterproof Connectors	2

LENS REPLACEMENT PARTS (INCLUDED: A/B)

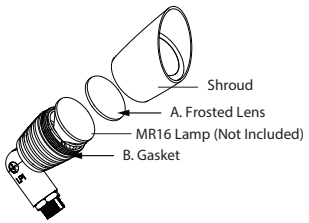

The fixture is supplied with a clear lens installed and an accessory frosted lens included. If the frosted lens is desired, follow these steps:

1. Prior to installing or servicing this product, disconnect the transformer from the main power supply.
2. Remove the shroud with hand by rotating the shroud counterclockwise from the fixture.
3. Put the frosted lens on the MR16 lamp (not included) and rotate the shroud clockwise by hand to tighten until snug.

Remove the fixture and the mounting package from the box and make sure that no parts are missing by referencing the illustrations on the installation instructions.

LAMP INSTALLATION/REPLACEMENT INSTRUCTIONS

1. Prior to installing or servicing this product, disconnect the transformer from the main power supply.
2. Remove the shroud with hand by rotating the shroud counterclockwise from the fixture.
3. Insert a G5.3 bi-pin MR16 LED lamp (15 watt maximum) into the socket.
4. Rotate the shroud clockwise to tighten until snug.

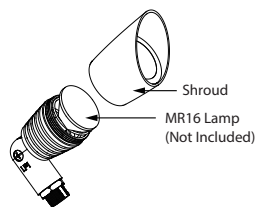

MR16 LED lamps have an operating voltage range of 10-15 volts AC. Operating LED lamps with voltage greater than 15V may damage the internal components of the LED and voids the manufacturer warranty. LED lamps maintain light output, full color, and instant start capabilities to temperatures down to -20 degrees Celsius. LED lamps will operate at the desired light output with voltage as low as 10V and as high as 15V, providing balanced light output from the fixture located closest to the transformer to the fixture located furthest from the transformer.

ASSEMBLY INSTRUCTIONS

1. Prior to installing or servicing this product, disconnect the transformer from the main power supply.
2. Insert the pigtail wires from the bottom of the fixture through the hole and slot located on the head of the mounting stake (BB).
3. Screw the fixture into the mounting stake (BB) hole.
4. Place the fixture/stake in the desired location. Insert the stake (BB) into the ground in the desired location until the bottom of the stake head rests on the ground surface.
5. Strip the two fixture pigtail wires. Attach the two fixture leads to the two main supply cable leads using the two provided waterproof connectors (CC). Please note that the fixture wiring should be buried no deeper than six inches to ensure connectivity to the main supply cable.
6. Using a Phillips head screwdriver, loosen the screw located in the knuckle. Angle the fixture to the desired position and retighten the screw.
7. Reconnect the transformer to the main power supply. Turn on the power to the fixture and verify proper position and operation.

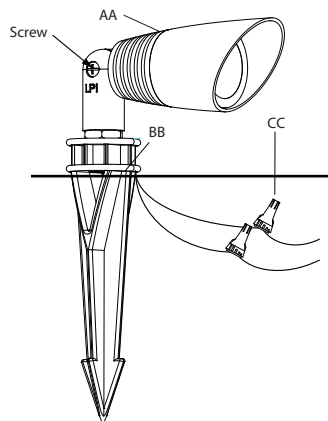

Note: In hard soil, the mounting stake can be inserted into the ground using a rubber mallet, prior to attaching the fixture.

TROUBLESHOOTING

- 1) The light does not come on at all:
 - a) Make sure the wall switch and circuit breaker are on.
 - b) Make sure the wiring is correct.
 - c) Following the steps outlined in the "LAMP INSTALLATION/REPLACEMENT INSTRUCTIONS" to check if the MR16 LED lamp is securely connected.
- 2) Fuse blows or circuit trips when light is turned on.
 - a) Check for crossed wires, ensure wiring is correct.

If unable to fix any of the above issues, please consult a certified electrician.

CARE AND MAINTENANCE

To clean, turn off and wipe with a damp, non-abrasive cloth.

problems, missing parts? Please visit our website www.landscapeproductsinc.com for contact information